



**ROTAIR®**

PORTABLE

---

COMPRESSORS



**SCREW**  
**SUPERSILENT**  
for civil  
engineering

GOMMAIR | DS | MDVN | D | MDVS | VRK | TVR | VRH

GENERAL  
CATALOGUE

---



**PRO**  
SERIES



**ROTAIR®**



powerful › compact

**MDVN**

**22 K - 26 K**



› SKID ADAPTOR

- › Design with modern, slender and aggressive line.
- › Electro-galvanized bodywork and chassis with advanced painting procedure to grant an excellent preservation through time.
- › Compact dimensions for easy handling and optimum dimensions/ delivered power ratio.
- › Light weight.
- › Filters "spin-on" type for quick maintenance
- › Full accessibility for easy and rapid maintenance and service.
- › Exclusive pneumatic control system, developed by ROTAIR, to adjust automatically engine revs, depending on the air to be delivered. This system is highly reliable and ensures fuel consumption saving.
- › Air/oil separator filter, highly oversized, can guarantee an excellent air/oil separation.

# Technical Data

## dimensions >

L = 2841 mm / 111.83"  
W = 1400 mm / 55.08"  
H = 1230 mm / 48.43"

## weight >

480 kg / 1060 lbs (without brakes)  
545 kg / 1200 lbs (with brakes)

## MDVN 22 K

## dimensions >

L = 2841 mm / 111.83"  
W = 1400 mm / 55.08"  
H = 1230 mm / 48.43"

## weight >

540 kg / 1190 lbs (without brakes)  
605 kg / 1330 lbs (with brakes)

## MDVN 26 K

### COMPRESSOR

(\*) = Possibility to have also other operating pressures up to 14/15 bar and Dual Pressure

Operating pressure (*)	6,5 bar 94 psi	10 bar 145 psi	12 bar 174 psi
Free air delivery	2000 l/min 71 cfm	1600 l/min 56 cfm	1400 l/min 50 cfm
Minimum working pressure	5,5 bar - 80 psi		
Drive system engine-airend	Belt Drive		
Compressor cooling system	Air / Oil		
Oil cooling capacity	6 lt - 1.32 UK gal		
Air outlet temperature	40°C - 105°F + Ambient temperature		
Outlet valves	2 x 3/4"		
Noise level EECno 2000/14	< 98 LWA		
Battery capacity	12V cc - 270A-55Ah (EN)		
Fuel tank capacity	30 lt - 6.6 UK gal		
Consumes	3,5 lt/h - 0.77 UK gal/h (8,5 working hours)		

### DIESEL ENGINE / ENVIRONMENTAL CONDITIONS

Engine make	KUBOTA
Engine type	D902-E4B
Engine system	4 strokes - Inline
Emissions	Stage V / Tier 4
Displacement	898 cc
N. cylinders	3
Aspiration	Natural
Max engine power @3600 RPM	18,5 kW - 25.0 HP
Max engine speed	3600 RPM
Min engine speed	1900 RPM
Cooling system	Water
Cooling system capacity	4 lt - 0.88 UK gal
Lubrication system	Oil
Lubrication system capacity	4 lt - 0.88 UK gal
Max ambient temperature	50°C - 122°F
Max altitude	1800 m a.s.l.
Min working temperature	-10°C / 14°F

Operating pressure (*)	6,5 bar 94 psi	10 bar 145 psi	12 bar 174 psi
Free air delivery	2500 l/min 88 cfm	1900 l/min 67 cfm	1400 l/min 50 cfm
Minimum working pressure	5,5 bar - 80 psi		
Drive system engine-airend	Belt Drive		
Compressor cooling system	Air / Oil		
Oil cooling capacity	6 lt - 1.32 UK gal		
Air outlet temperature	40°C - 105°F + Ambient temperature		
Outlet valves	2 x 3/4"		
Noise level EECno 2000/14	< 98 LWA		
Battery capacity	12V cc - 270A-55Ah (EN)		
Fuel tank capacity	30 lt - 6.6 UK gal		
Consumes	3,8 lt/h - 0.84 UK gal/h (8 working hours)		

Engine make	KUBOTA
Engine type	D1105-E4B
Engine system	4 strokes - Inline
Emissions	Stage V / Tier 4
Displacement	1123 cc
N. cylinders	3
Aspiration	Natural
Max engine power @3600 RPM	18,5 kW - 25.0 HP
Max engine speed	3000 RPM
Min engine speed	1900 RPM
Cooling system	Water
Cooling system capacity	4 lt - 0.88 UK gal
Lubrication system	Oil
Lubrication system capacity	5,1 lt - 1.12 UK gal
Max ambient temperature	50°C - 122°F
Max altitude	1800 m a.s.l.
Min working temperature	-10°C / 14°F

- ▶ The air and oil filters of the compressor and the air and oil filters of the engine are independent.
- ▶ Single stage oversized air filter for compressor part, to guarantee good filtering of the air intake by airend.
- ▶ Two-stage air filter for engine part.
- ▶ Combined radiator allowing both compressor oil cooling and engine liquid cooling.





**ROTAIR®**



powerful › compact

**MDVN**

**31K-37K**



› SKID ADAPTOR

- › Design with modern, slender and aggressive line.
- › Electro-galvanized bodywork and chassis with advanced painting procedure to grant an excellent preservation through time.
- › Compact dimensions for easy handling and optimum dimensions / delivered power ratio.
- › Light weight.
- › Filters "spin-on" type for quick maintenance.
- › Full accessibility for easy and rapid maintenance and service.
- › Exclusive pneumatic control system, developed by ROTAIR, to adjust automatically engine revs, depending on the air to be delivered. This system is highly reliable and ensures fuel consumption saving.
- › Start/stop "INTELLIGENT SYSTEM", exclusive from ROTAIR, to prevent the risk of incorrect procedures during specific functioning.
- › Air/oil separator filter, highly oversized, can guarantee an excellent air/oil separation.

# Technical Data

## dimensions >

L = 3025 mm / 119.09"

W = 1340 mm / 52.76"

H = 1302 mm / 51.26"

## weight >

625kg / 1377 lbs (without brakes)

650 kg / 1433 lbs (with brakes)

## MDVN 31K

## dimensions >

L = 3025 mm / 119.09"

W = 1340 mm / 52.76"

H = 1302 mm / 51.26"

## weight >

625 kg / 1377 lbs (without brakes)

650 kg / 1433 lbs (with brakes)

## MDVN 37K

### COMPRESSOR

(\*) = Possibility to have also other operating pressures up to 14/15 bar and Dual Pressure

Operating pressure (*)	7 bar 102 psi	10 bar 145 psi	12 bar 174 psi
Free air delivery	3000 l/min 106 cfm	2500 l/min 88 cfm	2000 l/min 71 cfm
Minimum working pressure	5 bar - 73 psi		
Drive system engine-airend	Direct Drive		
Compressor cooling system	Air / Oil		
Oil cooling capacity	8,1 lt - 1.78 UK gal		
Air outlet temperature	40°C - 105°F + Ambient temperature		
Outlet valves	2 x 3/4"		
Noise level EECno 2000/14	< 98 LWA		
Battery capacity	12V cc - 680A-74Ah (EN)		
Fuel tank capacity	40 lt - 8.8 UK gal		
Consumes	4,4 lt/h - 0.97 UK gal/h (9 working hours)		

### DIESEL ENGINE / ENVIRONMENTAL CONDITIONS

Engine make	KUBOTA
Engine type	V1505-E2B
Engine system	4 strokes - Inline
Emissions	Stage III A / Tier 4 Interim
Displacement	1498 cc
N. cylinders	4
Aspiration	Natural
Max engine power @3000 RPM	26,2 kW - 35.0 HP
Max engine speed	3000 RPM
Min engine speed	1600 RPM
Cooling system	Water
Cooling system capacity	5 lt - 1.1 UK gal
Lubrication system	Oil
Lubrication system capacity	6 lt - 1.32 UK gal
Max ambient temperature	50°C - 122°F
Max altitude	1800 m a.s.l.
Min working temperature	-10°C / 14°F

Operating pressure (*)	7 bar 102 psi	10 bar 145 psi	12 bar 174 psi
Free air delivery	3600 l/min 127 cfm	2900 l/min 102 cfm	2250 l/min 79 cfm
Minimum working pressure	5 bar - 73 psi		
Drive system engine-airend	Direct Drive		
Compressor cooling system	Air / Oil		
Oil cooling capacity	8,1 lt - 1.78 UK gal		
Air outlet temperature	40°C - 105°F + Ambient temperature		
Outlet valves	2 x 3/4"		
Noise level EECno 2000/14	< 98 LWA		
Battery capacity	12V cc - 680A-74Ah (EN)		
Fuel tank capacity	40 lt - 8.8 UK gal		
Consumes	4,9 lt/h - 1.08 UK gal/h (8 working hours)		

Engine make	KUBOTA
Engine type	V1505-E2B
Engine system	4 strokes - Inline
Emissions	Stage III A / Tier 4 Interim
Displacement	1498 cc
N. cylinders	4
Aspiration	Natural
Max engine power @3000 RPM	26,2 kW - 35.0 HP
Max engine speed	3000 RPM
Min engine speed	1600 RPM
Cooling system	Water
Cooling system capacity	5 lt - 1.1 UK gal
Lubrication system	Oil
Lubrication system capacity	6 lt - 1.32 UK gal
Max ambient temperature	50°C - 122°F
Max altitude	1800 m a.s.l.
Min working temperature	-10°C / 14°F

- › The air and oil filters of the compressor and the air and oil filters of the engine are independent.
- › Single stage oversized air filter for compressor part, to guarantee good filtering of the air intake by airend.
- › Two-stage air filter for engine part.
- › Combined radiator allowing both compressor oil cooling and engine liquid cooling.





**ROTAIR®**



powerful › compact

**MDVN**

**31 P - 37 P**



› SKID ADAPTOR

- › Design with modern, slender and aggressive line.
- › Electro-galvanized bodywork and chassis with advanced painting procedure to grant an excellent preservation through time.
- › Compact dimensions for easy handling and optimum dimensions / delivered power ratio.
- › Light weight.
- › Filters "spin-on" type for quick maintenance
- › Full accessibility for easy and rapid maintenance and service.
- › Exclusive pneumatic control system, developed by ROTAIR, to adjust automatically engine revs, depending on the air to be delivered. This system is highly reliable and ensures fuel consumption saving.
- › Start/stop "INTELLIGENT SYSTEM", exclusive from ROTAIR, to prevent the risk of incorrect procedures during specific functioning.
- › Air/oil separator filter, highly oversized, can guarantee an excellent air/oil separation.

# Technical Data

## dimensions >

L = 3025 mm / 119.09"

W = 1340 mm / 52.76"

H = 1302 mm / 51.26"

## weight >

650 kg / 1433 lbs (without brakes)

660 kg / 1455 lbs (with brakes)

## MDVN 31 P

## dimensions >

L = 3025 mm / 119.09"

W = 1340 mm / 52.76"

H = 1302 mm / 51.26"

## weight >

650 kg / 1433 lbs (without brakes)

660 kg / 1455 lbs (with brakes)

## MDVN 37 P

### COMPRESSOR

(\*) = Possibility to have also other operating pressures up to 14/15 bar and Dual Pressure

Operating pressure (*)	7 bar 102 psi	10 bar 145 psi	12 bar 174 psi
Free air delivery	3000 l/min 106 cfm	2500 l/min 88 cfm	2000 l/min 71 cfm
Minimum working pressure	5 bar - 73 psi		
Drive system engine-arend	Direct Drive		
Compressor cooling system	Air / Oil		
Oil cooling capacity	7 lt - 1.54 UK gal		
Air outlet temperature	40°C - 105°F + Ambient temperature		
Outlet valves	2 x 3/4"		
Noise level EECno 2000/14	< 98 LWA		
Battery capacity	12V cc - 680A-74Ah (EN)		
Fuel tank capacity	40 lt - 8.8 UK gal		
Consumes	4,6 lt/h - 1.01 UK gal/h (8,7 working hours)		

### DIESEL ENGINE / ENVIRONMENTAL CONDITIONS

Engine make	PERKINS
Engine type	403D-15
Engine system	4 strokes - Inline
Emissions	Stage III A / Tier 3
Displacement	1496 cc
N. cylinders	3
Aspiration	Natural
Max engine power @3000 RPM	25,1 kW - 34.1 HP
Max engine speed	3000 RPM
Min engine speed	1900 RPM
Cooling system	Water
Cooling system capacity	5 lt - 1.1 UK gal
Lubrication system	Oil
Lubrication system capacity	5 lt - 1.1 UK gal
Max ambient temperature	50°C - 122°F
Max altitude	1800 m a.s.l.
Min working temperature	-10°C / 14°F

Operating pressure (*)	7 bar 102 psi	10 bar 145 psi	12 bar 174 psi
Free air delivery	3600 l/min 127 cfm	2900 l/min 102 cfm	2250 l/min 79 cfm
Minimum working pressure	5 bar - 73 psi		
Drive system engine-arend	Direct Drive		
Compressor cooling system	Air / Oil		
Oil cooling capacity	7 lt - 1.54 UK gal		
Air outlet temperature	40°C - 105°F + Ambient temperature		
Outlet valves	2 x 3/4"		
Noise level EECno 2000/14	< 98 LWA		
Battery capacity	12V cc - 680A-74Ah (EN)		
Fuel tank capacity	40 lt - 8.8 UK gal		
Consumes	4,9 lt/h - 1.08 UK gal/h (8,2 working hours)		

Engine make	PERKINS
Engine type	403D-15
Engine system	4 strokes - Inline
Emissions	Stage III A / Tier 3
Displacement	1496 cc
N. cylinders	3
Aspiration	Natural
Max engine power @3000 RPM	25,1 kW - 34.1 HP
Max engine speed	3000 RPM
Min engine speed	1900 RPM
Cooling system	Water
Cooling system capacity	5 lt - 1.1 UK gal
Lubrication system	Oil
Lubrication system capacity	5 lt - 1.1 UK gal
Max ambient temperature	50°C - 122°F
Max altitude	1800 m a.s.l.
Min working temperature	-10°C / 14°F

- › The air and oil filters of the compressor and the air and oil filters of the engine are independent.
- › Single stage oversized air filter for compressor part, to guarantee good filtering of the air intake by arend.
- › Two-stage air filter for engine part.
- › Combined radiator allowing both compressor oil cooling and engine liquid cooling.





**ROTAIR®**



powerful › compact

**MDVN**

**46 K-53 K**



› SKID ADAPTOR

- › Design with modern, slender and aggressive line.
- › Electro-galvanized bodywork and chassis with advanced painting procedure to grant an excellent preservation through time.
- › Compact dimensions for easy handling and optimum dimensions / delivered power ratio.
- › Light weight.
- › Filters "spin-on" type for quick maintenance.
- › Full accessibility for easy and rapid maintenance and service.
- › Exclusive pneumatic control system, developed by ROTAIR, to adjust automatically engine revs, depending on the air to be delivered. This system is highly reliable and ensures fuel consumption saving.
- › Start/stop "INTELLIGENT SYSTEM", exclusive from ROTAIR, to prevent the risk of incorrect procedures during specific functioning.
- › Air/oil separator filter, highly oversized, can guarantee an excellent air/oil separation.



# Technical Data

## dimensions >

L = 3132 mm / 123.31"  
W = 1340 mm / 52.76"  
H = 1361 mm / 53.57"

## weight >

800 kg / 1765 lbs (without brakes)  
856 kg / 1888 lbs (with brakes)

## MDVN 46 K

## dimensions >

L = 3132 mm / 123.31"  
W = 1340 mm / 52.76"  
H = 1361 mm / 53.57"

## weight >

800 kg / 1765 lbs (without brakes)  
856 kg / 1888 lbs (with brakes)

## MDVN 53 K

### COMPRESSOR

(\*) = Possibility to have also other operating pressures up to 14/15 bar and Dual Pressure

Operating pressure (*)	7 bar 102 psi	10 bar 145 psi	12 bar 174 psi
Free air delivery	4500 l/min 159 cfm	3650 l/min 129 cfm	3400 l/min 120 cfm
Minimum working pressure	5 bar - 73 psi		
Drive system engine-airend	Direct Drive		
Compressor cooling system	Air / Oil		
Oil cooling capacity	10 lt - 2.2 UK gal		
Air outlet temperature	40°C - 105°F + Ambient temperature		
Outlet valves	2 x 3/4" + 1 x 1/1"		
Noise level EECno 2000/14	< 98 LWA		
Battery capacity	12V cc - 680A-74Ah (EN)		
Fuel tank capacity	50 lt - 11 UK gal		
Consumes	6,5 lt/h - 1.43 UK gal/h (8 working hours)		

Operating pressure (*)	7 bar 102 psi	10 bar 145 psi	12 bar 174 psi
Free air delivery	5200 l/min 185 cfm	4150 l/min 147 cfm	3800 l/min 134 cfm
Minimum working pressure	5 bar - 73 psi		
Drive system engine-airend	Direct Drive		
Compressor cooling system	Air / Oil		
Oil cooling capacity	10 lt - 2.2 UK gal		
Air outlet temperature	40°C - 105°F + Ambient temperature		
Outlet valves	2 x 3/4" + 1 x 1/1"		
Noise level EECno 2000/14	< 98 LWA		
Battery capacity	12V cc - 680A-74Ah (EN)		
Fuel tank capacity	50 lt - 11 UK gal		
Consumes	6,7 lt/h - 1.47 UK gal/h (8 working hours)		

### DIESEL ENGINE / ENVIRONMENTAL CONDITIONS

Engine make	KUBOTA
Engine type	V-2403-M-DI
Engine system	4 strokes - Inline - Direct Injection
Emissions	Stage III A / Tier 4 Interim
Displacement	2434 cc
N. cylinders	4
Aspiration	Natural
Max engine power @3000 RPM	36,5 kW - 49.0 HP
Max engine speed	2700 RPM
Min engine speed	1600 RPM
Cooling system	Water
Cooling system capacity	8 lt - 1.76 UK gal
Lubrication system	Oil
Lubrication system capacity	9,5 lt - 2.09 UK gal
Max ambient temperature	50°C - 122°F
Max altitude	1800 m a.s.l.
Min working temperature	-10°C / 14°F

Engine make	KUBOTA
Engine type	V-2403-M-DI
Engine system	4 strokes - Inline - Direct Injection
Emissions	Stage III A / Tier 4 Interim
Displacement	2434 cc
N. cylinders	4
Aspiration	Natural
Max engine power @3000 RPM	36,5 kW - 49.0 HP
Max engine speed	2700 RPM
Min engine speed	1600 RPM
Cooling system	Water
Cooling system capacity	8 lt - 1.76 UK gal
Lubrication system	Oil
Lubrication system capacity	9,5 lt - 2.09 UK gal
Max ambient temperature	50°C - 122°F
Max altitude	1800 m a.s.l.
Min working temperature	-10°C / 14°F

- › The air and oil filters of the compressor and the air and oil filters of the engine are independent.
- › Single stage oversized air filter for compressor part, to guarantee good filtering of the air intake by airend.
- › Two-stage air filter for engine part.
- › Combined radiator allowing both compressor oil cooling and engine liquid cooling.





powerful › compact

# D

# 200 Y



## › SKID ADAPTOR

- › Design with modern, slender and aggressive line.
- › Electro-galvanized bodywork and chassis with advanced painting procedure to grant an excellent preservation through time.
- › Compact dimensions for easy handling and optimum dimensions / delivered power ratio.
- › Light weight.
- › Filters “spin-on” type for quick maintenance.
- › Full accessibility for easy and rapid maintenance and service.
- › Exclusive pneumatic control system, developed by ROTAIR, to adjust automatically engine revs, depending on the air to be delivered. This system is highly reliable and ensures fuel consumption saving.
- › Start/stop “INTELLIGENT SYSTEM”, exclusive from ROTAIR, to prevent the risk of incorrect procedures during specific functioning.
- › Air/oil separator filter, highly oversized, can guarantee an excellent air/oil separation.



# Technical Data

## dimensions >

L = 3024 mm / 119.04"

W = 1340 mm / 52.76"

H = 1361 mm / 53.57"

## weight >

800 kg / 1765 lbs (without brakes)

856 kg / 1888 lbs (with brakes)

# D 200 Y

## COMPRESSOR

Operating pressure	<b>7 bar 102 psi</b>
Free air delivery	<b>5650 lt/min 200 cfm</b>
Minimum working pressure	<b>5 bar - 73 psi</b>
Drive system engine-arend	<b>Direct Drive</b>
Compressor cooling system	<b>Air / Oil</b>
Oil cooling capacity	<b>8 lt - 1.76 UK gal</b>
Air outlet temperature	<b>40°C - 105°F + Ambient temperature</b>
Outlet valves	<b>3 x 3/4"</b>
Battery capacity	<b>12V cc - 750A-74Ah (EN)</b>
Fuel tank capacity	<b>50 lt - 11 UK gal</b>
Consumes	<b>10,3 lt/h @100% - 6.2 l/h @60% 2.26 UK gal/h @100% - 1.36 UK gal/h@60%</b>

## DIESEL ENGINE / ENVIRONMENTAL CONDITIONS

Engine make	<b>YANMAR</b>
Engine type	<b>4TNV88 - DSAP</b>
Engine system	<b>4 strokes - Inline</b>
Emissions	<b>Stage III A / Tier 2</b>
Displacement	<b>2190 cc</b>
N. cylinders	<b>4</b>
Aspiration	<b>Natural</b>
Max engine power @2600 RPM	<b>35,4 kW - 48 HP</b>
Max engine speed	<b>3000 RPM</b>
Min engine speed	<b>1500 RPM</b>
Cooling system	<b>Water</b>
Cooling system capacity	<b>8 lt - 1.76 UK gal</b>
Lubrication system	<b>Oil</b>
Lubrication system capacity	<b>7,4 lt - 1.63 UK gal</b>
Max ambient temperature	<b>48°C - 118°F</b>
Max altitude	<b>1800 m a.s.l.</b>
Min working temperature	<b>-10°C / 14°F</b>

- › The air and oil filters of the compressor and the air and oil filters of the engine are independent.
- › Single stage oversized air filter for compressor part, to guarantee good filtering of the air intake by airend.
- › Two-stage air filter for engine part.
- › Combined radiator allowing both compressor oil cooling and engine liquid cooling.

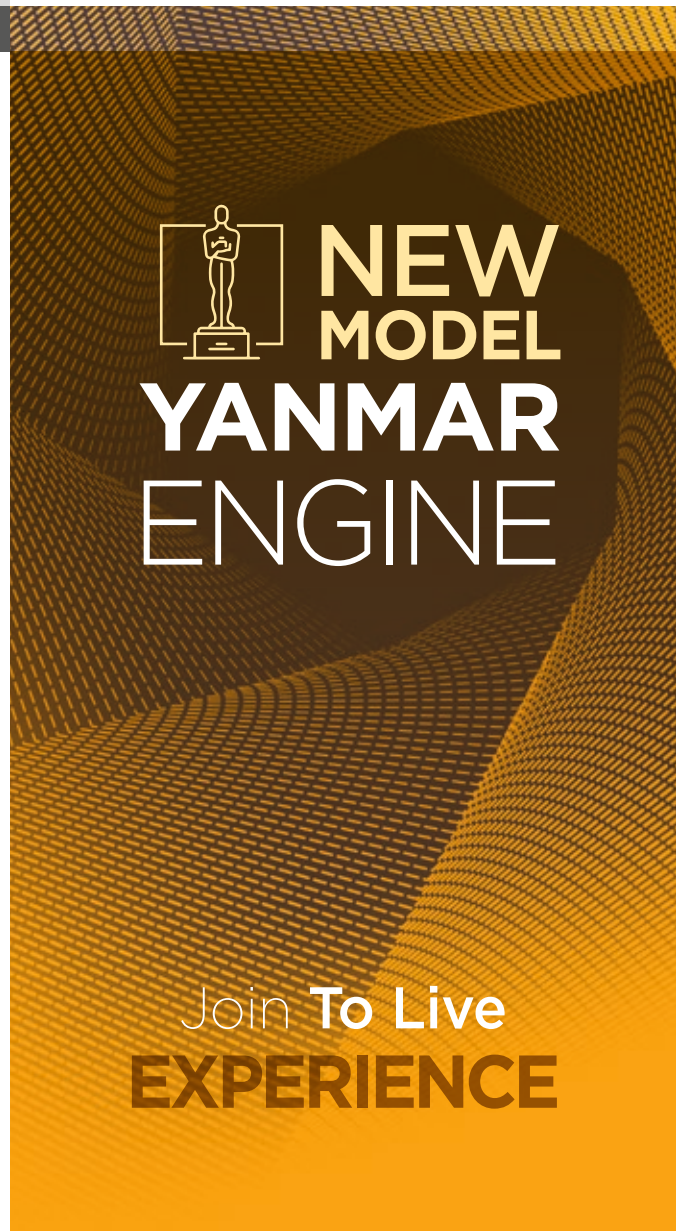



**ROTAIR®**



powerful › compact

**MDVN**

**46-53 Eco5**



✂ | SKID ADAPTOR

- › Design with modern, slender and aggressive line.
- › Electro-galvanized bodywork and chassis with advanced painting procedure to grant an excellent preservation through time.
- › Compact dimensions for easy handling and optimum dimensions / delivered power ratio.
- › Light weight.
- › Filters "spin-on" type for quick maintenance.
- › Full accessibility for easy and rapid maintenance and service.
- › Exclusive pneumatic control system, developed by ROTAIR, to adjust automatically engine revs, depending on the air to be delivered. This system is highly reliable and ensures fuel consumption saving.
- › Start/stop "INTELLIGENT SYSTEM", exclusive from ROTAIR, to prevent the risk of incorrect procedures during specific functioning.
- › Air/oil separator filter, highly oversized, can guarantee an excellent air/oil separation.

# Technical Data

## dimensions >

L = 3122 mm / 122.9"

W = 1520 mm / 59.8"

H = 1490 mm / 58.7"

## weight >

960 kg / 2116 lbs (without brakes)

1035 kg / 2282 lbs (with brakes)

## MDVN 46 Eco5

## dimensions >

L = 3122 mm / 122.9"

W = 1520 mm / 59.8"

H = 1490 mm / 58.7"

## weight >

960 kg / 2116 lbs (without brakes)

1035 kg / 2282 lbs (with brakes)

## MDVN 53 Eco5

### COMPRESSOR

	7 bar 102 psi	10 bar 145 psi	12 bar 174 psi
Operating pressure			
Free air delivery	4500 lt/min 159 cfm	3650 lt/min 129 cfm	3550 lt/min 125 cfm
Minimum working pressure	5 bar - 73 psi		
Drive system engine-arend	Direct Drive		
Compressor cooling system	Air / Oil		
Oil cooling capacity	10,7 lt - 2.35 UK gal		
Air outlet temperature	40°C - 105°F + Ambient temperature		
Outlet valves	2 x 3/4"		
Noise level EECno 2000/14	< 98 LWA		
Battery capacity	12V cc - 750A-100Ah (EN)		
Fuel tank capacity	88 lt - 19.36 UK gal		
Fuel tank capacity	10.8 lt/h @ 100% - 6.5 lt/h @ 60% 2.38 UK gal/h @ 100% - 1.43 UK gal/h @ 60%		

### DIESEL ENGINE / ENVIRONMENTAL CONDITIONS

Engine make	KOHLER
Engine type	KDI 1903 TCR St V
Engine system	4 strokes - Inline - Indirect Injection
Emissions	Stage V / Tier 4 Final
Filtration	DOC + DPF
Displacement	1903 cc
N. cylinders	3
Aspiration	Turbocompress
Max engine power @2600 RPM	36,5 kW - 49.0 HP
Max engine speed	2450 RPM
Min engine speed	1700 RPM
Cooling system	Water
Cooling system capacity	14 lt- 3.08 UK gal
Lubrication system	Oil
Lubrication system capacity	9,75 lt - 2.14 UK gal
Max ambient temperature	45°C - 113°F
Max altitude	1800 m s.n.m.
Min working temperature	-10°C / 14°F

	7 bar 102 psi	10 bar 145 psi	12 bar 174 psi
Operating pressure			
Free air delivery	5000 lt/min 177 cfm	4900 lt/min 175 cfm	3700 lt/min 132 cfm
Minimum working pressure	5 bar - 73 psi		
Drive system engine-arend	Direct Drive		
Compressor cooling system	Air / Oil		
Oil cooling capacity	10,7 lt - 2.35 UK gal		
Air outlet temperature	40°C - 105°F + Ambient temperature		
Outlet valves	2 x 3/4"		
Noise level EECno 2000/14	< 98 LWA		
Battery capacity	12V cc - 750A-100Ah (EN)		
Fuel tank capacity	88 lt - 19.36 UK gal		
Fuel tank capacity	10.8 lt/h @ 00% - 6.5 lt/h @ 60% 2.38 UK gal/h @ 100% - 1.43 UK gal/h @ 60%		

Engine make	KOHLER
Engine type	KDI 1903 TCR St V
Engine system	4 strokes - Inline - Indirect Injection
Emissions	Stage V / Tier 4 Final
Filtration	DOC + DPF
Displacement	1903 cc
N. cylinders	3
Aspiration	Turbocompress
Max engine power @2600 RPM	36,5 kW - 49.0 HP
Max engine speed	2450 RPM
Min engine speed	1700 RPM
Cooling system	Water
Cooling system capacity	14 lt - 3.08 UK gal
Lubrication system	Oil
Lubrication system capacity	9,75 lt- 2.14 UK gal
Max ambient temperature	45°C - 113°F
Max altitude	1800 m s.n.m.
Min working temperature	-10°C / 14°F

- › The air and oil filters of the compressor and the air and oil filters of the engine are independent.
- › Single stage oversized air filter for compressor part, to guarantee good filtering of the air intake by airend.
- › Two-stage air filter for engine part.
- › Combined radiator allowing both compressor oil cooling and engine liquid cooling.





**ROTAIR®**



powerful › compact

**MDVN**

**46 P - 53 P**



✦ | **SKID ADAPTOR**

- › Design with modern, slender and aggressive line.
- › Electro-galvanized bodywork and chassis with advanced painting procedure to grant an excellent preservation through time.
- › Compact dimensions for easy handling and optimum dimensions / delivered power ratio.
- › Light weight.
- › Filters "spin-on" type for quick maintenance.
- › Full accessibility for easy and rapid maintenance and service.
- › Exclusive pneumatic control system, developed by ROTAIR, to adjust automatically engine revs, depending on the air to be delivered. This system is highly reliable and ensures fuel consumption saving.
- › Start/stop "INTELLIGENT SYSTEM", exclusive from ROTAIR, to prevent the risk of incorrect procedures during specific functioning.
- › Air/oil separator filter, highly oversized, can guarantee an excellent air/oil separation.



# Technical Data

## dimensions >

L = 3132 mm / 123.31"  
W = 1340 mm / 52.76"  
H = 1361 mm / 53.57"

## weight >

850 kg / 1873 lbs (without brakes)  
870 kg / 1918 lbs (with brakes)

## MDVN 46 P

## dimensions >

L = 3132 mm / 123.31"  
W = 1340 mm / 52.76"  
H = 1361 mm / 53.57"

## weight >

850 kg / 1873 lbs (without brakes)  
870 kg / 1918 lbs (with brakes)

## MDVN 53 P

### COMPRESSOR

(\*) = Possibility to have also other operating pressures up to 14/15 bar and Dual Pressure

Operating pressure (*)	7 bar 102 psi	10 bar 145 psi	12 bar 174 psi
Free air delivery	4500 l/min 159 cfm	3800 l/min 134 cfm	3450 l/min 122 cfm
Minimum working pressure	5 bar - 73 psi		
Drive system engine-arend	Direct Drive		
Compressor cooling system	Air / Oil		
Oil cooling capacity	10 lt - 2.2 UK gal		
Air outlet temperature	40°C - 105°F + Ambient temperature		
Outlet valves	2 x 3/4" + 1 x 1"		
Noise level EECno 2000/14	< 98 LWA		
Battery capacity	12V cc - 680A-74Ah (EN)		
Fuel tank capacity	50 lt - 11 UK gal		
Consumes	6,6 lt/h - 1.45 UK gal/h (7,5 working hours)		

### DIESEL ENGINE / ENVIRONMENTAL CONDITIONS

Engine make	PERKINS
Engine type	404D-22
Engine system	4 strokes - Inline
Emissions	Stage III A / Tier 2
Displacement	2216 cc
N. cylinders	4
Aspiration	Natural
Max engine power @3000 RPM	37,0 kW - 50.0 HP
Max engine speed	2900 RPM
Min engine speed	1700 RPM
Cooling system	Water
Cooling system capacity	8 lt - 1.76 UK gal
Lubrication system	Oil
Lubrication system capacity	9 lt - 1.98 UK gal
Max ambient temperature	50°C - 122°F
Max altitude	1800 m a.s.l.
Min working temperature	-10°C / 14°F

Operating pressure (*)	7 bar 102 psi	10 bar 145 psi	12 bar 174 psi
Free air delivery	5200 l/min 185 cfm	4400 l/min 155 cfm	4000 l/min 141 cfm
Minimum working pressure	5 bar - 73 psi		
Drive system engine-arend	Direct Drive		
Compressor cooling system	Air / Oil		
Oil cooling capacity	10 lt - 2.2 UK gal		
Air outlet temperature	40°C - 105°F + Ambient temperature		
Outlet valves	2 x 3/4" + 1 x 1"		
Noise level EECno 2000/14	< 98 LWA		
Battery capacity	12V cc - 680A-74Ah (EN)		
Fuel tank capacity	50 lt - 11 UK gal		
Consumes	7,2 lt/h - 1.58 UK gal/h (6,9 working hours)		

Engine make	PERKINS
Engine type	404D-22
Engine system	4 strokes - Inline
Emissions	Stage III A / Tier 2
Displacement	2216 cc
N. cylinders	4
Aspiration	Natural
Max engine power @3000 RPM	37,0 kW - 50.0 HP
Max engine speed	2900 RPM
Min engine speed	1700 RPM
Cooling system	Water
Cooling system capacity	8 lt - 1.76 UK gal
Lubrication system	Oil
Lubrication system capacity	9 lt - 1.98 UK gal
Max ambient temperature	50°C - 122°F
Max altitude	1800 m a.s.l.
Min working temperature	-10°C / 14°F

- > The air and oil filters of the compressor and the air and oil filters of the engine are independent.
- > Single stage oversized air filter for compressor part, to guarantee good filtering of the air intake by arend.
- > Two-stage air filter for engine part.
- > Combined radiator allowing both compressor oil cooling and engine liquid cooling.



**ROTAIR®**



powerful › compact

**MDVN**

**54 Y**



✦ | SKID ADAPTOR

› Electro-galvanized bodywork and chassis with advanced painting procedure to grant an excellent preservation through time.

- › Full accessibility for easy and rapid maintenance and service.
- › Exclusive pneumatic control system, developed by ROTAIR, to adjust automatically engine revs, depending on the air to be delivered. This system is highly reliable and ensures fuel consumption saving.
- › Start/stop "INTELLIGENT SYSTEM", exclusive from ROTAIR, to prevent the risk of incorrect procedures during specific functioning.

# Technical Data

## dimensions >

L = 3264 mm / 10' 7"

W = 1528 mm / 5' 0"

H = 1470 mm / 4' 8"

## weight >

950 kg / 2094 lbs (without brakes)

## MDVN 54 Y

# NEW!

### COMPRESSOR

Operating pressure	7 bar 102 psi
Free air delivery	5400 l/min 190 cfm
Drive system engine-airend	Direct Drive
Compressor cooling system	Air / Oil
Oil cooling capacity	10 lt - 2.2 UK gal
Air outlet temperature	40°C - 105°F + Ambient temperature
Outlet valves	2 x 1"
Battery capacity	12V cc - 750A-100Ah (EN)
Fuel tank capacity	54 lt - 11.88 UK gal
Consumes	6,6 lt/h - 1.45 UK gal/h (7,5 working hours)

### DIESEL ENGINE / ENVIRONMENTAL CONDITIONS

Engine make	YANMAR
Engine type	4TNV 88-DSAP
Engine system	4 strokes - Inline
Emissions	Stage III A / Tier 2
Displacement	2190 cc
N. cylinders	4
Aspiration	Natural
Max engine power @2600 RPM	35 kW - 46.9 HP
Max engine speed	3000 RPM
Min engine speed	1500 RPM
Cooling system	Water
Cooling system capacity	8 lt - 1.76 UK gal (glicole 50%)
Lubrication system	Oil
Lubrication system capacity	7 lt - 1.54 UK gal
Max ambient temperature	50°C - 122°F
Max altitude	1800 m a.s.l.
Min working temperature	-10°C / 14°F



**NEW  
MODEL  
YANMAR  
ENGINE**

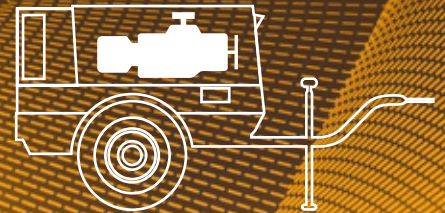

Join To Live  
**EXPERIENCE**



**ROTAIR®**



powerful › compact

**MDVN**

**72 Y**



✂ | **SKID ADAPTOR**

- › Design with modern, slender and aggressive line.
- › Electro-galvanized bodywork and chassis with advanced painting procedure to grant an excellent preservation through time.
- › Compact dimensions for easy handling and optimum dimensions / delivered power ratio.
- › Light weight.

- › Filters "spin-on" type for quick maintenance.
- › Full accessibility for easy and rapid maintenance and service.
- › Exclusive pneumatic control system, developed by ROTAIR, to adjust automatically engine revs, depending on the air to be delivered. This system is highly reliable and ensures fuel consumption saving.
- › Start/stop "INTELLIGENT SYSTEM", exclusive from ROTAIR, to prevent the risk of incorrect procedures during specific functioning.
- › Air/oil separator filter, highly oversized, can guarantee an excellent air/oil separation.

# Technical Data

## dimensions >

L = 3491 mm / 137.45"  
W = 1580 mm / 62.20"  
H = 1680 mm / 66.14"

## weight >

1240 kg / 2734 lbs (without brakes)

## MDVN 72 Y

# NEW!

### COMPRESSOR

Operating pressure	7 bar 102 psi	10 bar 145 psi	12 bar 174 psi
Free air delivery	7100 l/min 250 cfm	6400 l/min 226 cfm	4600 l/min 162 cfm
Minimum working pressure	5,5 bar - 80 psi		
Drive system engine-arend	Direct Drive		
Compressor cooling system	Air / Oil		
Outlet valves	2 x 3/4" + 1 x 1"		
Battery capacity	12V cc - 750A-100Ah (EN)		
Fuel tank capacity	92 lt - 20.24 UK gal		
Consumes	8,44 lt/h - 1.86 UK gal/h (10,9 working hours)		

### DIESEL ENGINE / ENVIRONMENTAL CONDITIONS

Engine make	YANMAR
Engine type	4TNV 98-hsap
Engine system	4 strokes - Inline - Direct Injection
Emissions	Stage II / Tier 2
Displacement	3519 cc
N. cylinders	4
Aspiration	Natural
Max engine power @2500 RPM	50,7 kW - 68.9 HP
Max engine speed	2500 RPM
Min engine speed	1500 RPM
Cooling system	Water
Cooling system capacity	12 lt - 2.64 UK gal
Lubrication system	Oil
Max ambient temperature	50°C - 122°F
Max altitude	1800 m a.s.l.
Min working temperature	-10°C / 14°F



**NEW  
MODEL  
YANMAR  
ENGINE**

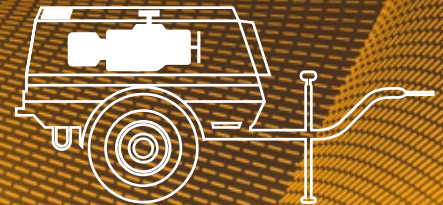

Join To Live  
**EXPERIENCE**

- › The air and oil filters of the compressor and the air and oil filters of the engine are independent.
- › Two stages oversized air filter for compressor part, to guarantee good filtering of the air intake by airend.
- › Two-stage air filter for engine part.
- › Combined radiator allowing both compressor oil cooling and engine liquid cooling.





powerful › compact

# MDVN

# 80 Y



## SKID ADAPTOR

- › Design with modern, slender and aggressive line.
- › Electro-galvanized bodywork and chassis with advanced painting procedure to grant an excellent preservation through time.
- › Compact dimensions for easy handling and optimum dimensions / delivered power ratio.
- › Light weight.
- › Filters "spin-on" type for quick maintenance.
- › Full accessibility for easy and rapid maintenance and service.
- › Exclusive pneumatic control system, developed by ROTAIR, to adjust automatically engine revs, depending on the air to be delivered. This system is highly reliable and ensures fuel consumption saving.
- › Start/stop "INTELLIGENT SYSTEM", exclusive from ROTAIR, to prevent the risk of incorrect procedures during specific functioning.
- › Air/oil separator filter, highly oversized, can guarantee an excellent air/oil separation.



# Technical Data

## dimensions >

L = 3491 mm / 137.45"  
W = 1580 mm / 62.20"  
H = 1680 mm / 66.14"

## weight >

1240 kg / 2734 lbs (without brakes)

## MDVN 80 Y

# NEW!

### COMPRESSOR

Operating pressure	7 bar 102 psi	10 bar 145 psi	12 bar 174 psi
Free air delivery	7800 l/min 275 cfm	6800 l/min 240 cfm	4900 l/min 173 cfm
Minimum working pressure	5,5 bar - 80 psi		
Drive system engine-arend	Direct Drive		
Compressor cooling system	Air / Oil		
Outlet valves	2 x 3/4" + 1 x 1"		
Battery capacity	12V cc - 750A-100Ah (EN)		
Fuel tank capacity	92 lt - 20.24 UK gal		
Consumes	8,9 lt/h - 1.96 UK gal/h (10,3 working hours)		

### DIESEL ENGINE / ENVIRONMENTAL CONDITIONS

Engine make	YANMAR
Engine type	4TNV 98-hsap
Engine system	4 strokes - Inline - Direct Injection
Emissions	Stage II / Tier 2
Displacement	3519 cc
N. cylinders	4
Aspiration	Natural
Max engine power @2500 RPM	50,7 kW - 68.9 HP
Max engine speed	2500 RPM
Min engine speed	1500 RPM
Cooling system	Water
Cooling system capacity	12 lt - 2.64 UK gal
Lubrication system	Oil
Max ambient temperature	50°C - 122°F
Max altitude	1800 m a.s.l.
Min working temperature	-10°C / 14°F



**NEW  
MODEL  
YANMAR  
ENGINE**

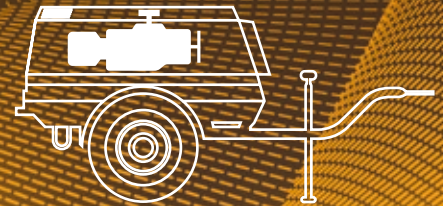

Join To Live  
**EXPERIENCE**

- > The air and oil filters of the compressor and the air and oil filters of the engine are independent.
- > Two stages oversized air filter for compressor part, to guarantee good filtering of the air intake by airend.
- > Two-stage air filter for engine part.
- > Combined radiator allowing both compressor oil cooling and engine liquid cooling.

# ROTAIR®



powerful › compact

# MDVN

# 83 Eco5



✂ | SKID ADAPTOR

- › Design with modern, slender and aggressive line.
- › Electro-galvanized bodywork and chassis with advanced painting procedure to grant an excellent preservation through time.
- › Compact dimensions for easy handling and optimum dimensions / delivered power ratio.
- › Light weight.
- › Kohler Stage V-Tier Final compliant, with aftertreatment system DOC+DPF
- › Full accessibility for easy and rapid maintenance and service.
- › Exclusive pneumatic control system, developed by ROTAIR, to adjust automatically engine revs, depending on the air to be delivered. This system is highly reliable and ensures fuel consumption saving.
- › Start/stop "INTELLIGENT SYSTEM", exclusive from ROTAIR, to prevent the risk of incorrect procedures during specific functioning.
- › Air/oil separator filter, highly oversized, can guarantee an excellent air/oil separation.



# Technical Data

## dimensions >

L = 3491 mm / 137.44"

W = 1580 mm / 62.2"

H = 1682 mm / 66.23"

## weight >

1320 kg / 2910 lbs (without brakes)

1395 kg / 3075 lbs (with brakes)

## MDVN 83 Eco5

# NEW TYPE

### COMPRESSOR

Operating pressure	7 bar 102 psi	10 bar 145 psi	12 bar 174 psi
Free air delivery	8000 lt/min 282 cfm	6400 lt/min 226 cfm	5600 lt/min 198 cfm
Minimum working pressure	5 bar - 73 psi		
Drive system engine-arend	Direct Drive		
Compressor cooling system	Air / Oil		
Oil cooling capacity	16 l - 3.52 UK gal		
Air outlet temperature	40°C - 105°F + Ambient temperature		
Outlet valves	2 x 3/4" + 1 x 1"		
Noise level EECno 2000/14	< 98 LWA		
Battery capacity	12V cc - 750A-80Ah (EN)		
Fuel tank capacity	140 lt - 30.80 UK gal		
Consumes	13,4 lt/h @ 100% - 7,2 lt/h @ 60% 2.95 UK gal/h @ 100% - 1.58 UK gal/h @ 60%		

### DIESEL ENGINE / ENVIRONMENTAL CONDITIONS

Engine make	KOHLER
Engine type	KDI 2504-TCR St V
Engine system	4 strokes - Inline - Indirect Injection
Emissions	Stage V / Tier 4 Final
Filtration	DOC + DPF
Displacement	2482 cc
N. cylinders	4
Aspiration	Turbo
Max engine power @2600 RPM	55,4 kW - 75.3 HP
Max engine speed	2100 RPM
Min engine speed	1700 RPM
Cooling system	Water
Cooling system capacity	18 lt- 3.96 UK gal
Lubrication system	Oil
Lubrication system capacity	9 lt - 1.98 UK gal
Max ambient temperature	50°C - 122°F
Max altitude	1800 m s.n.m.
Min working temperature	-10°C / 14°F

# NEW ENGINE



Join To Live  
**EXPERIENCE**

ask for  
**TRY IT!**

- › The air and oil filters of the compressor and the air and oil filters of the engine are independent.
- › Single stage oversized air filter for compressor part, to guarantee good filtering of the air intake by airend.
- › Two-stage air filter for engine part.
- › Combined radiator allowing both compressor oil cooling and engine liquid cooling.





we are focused on

# SAND BLASTING MODE

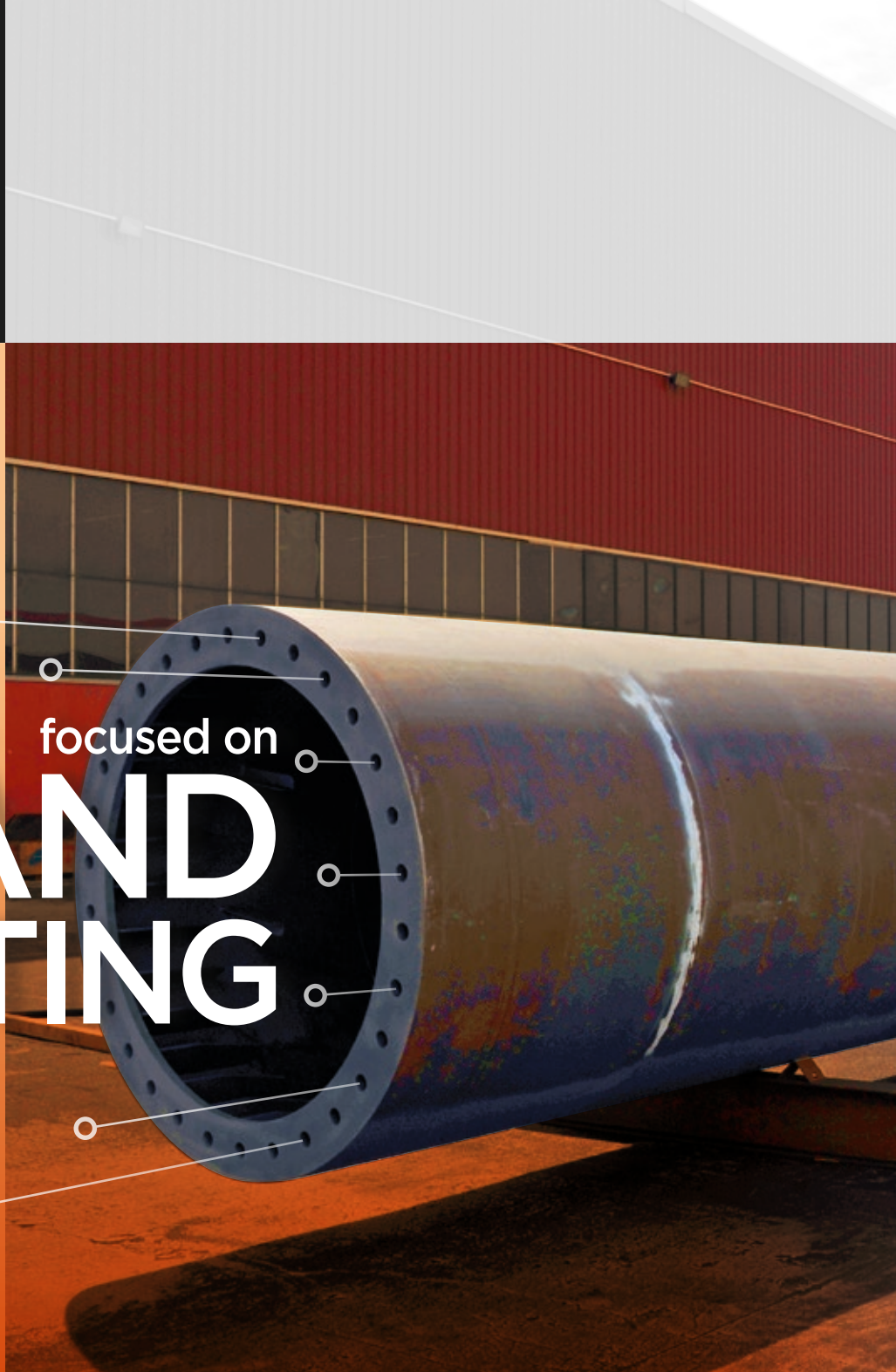

## AFTER COOLED SANDBLASTING

All models of **ROTAIR** compressors have specific aftercooled versions.

They feature an additional cooler to cool down compressed air and a specific condensate separator, that drains the water produced by the thermic exchange of the cooler.

This gives a cooler output of compressed air (ambient  $+12 \pm 2^{\circ}\text{C}$ ) and significantly lowers the humidity of the air, although not removing completely the moisture from air, as this depends mainly on the environmental conditions.

## INBUILT ADDITIONAL COOLER AND SPECIFIC CONDENSATE SEPARATOR

*for cool and dry air*

*specifically*  
designed for...



The aftercooled versions are called "**SANDBLASTING**" because the main use of these machines finds its operation in the sandblasting sector. These machines are indicated for all operations that are sensitive to humidity of the air output: optic fibre laying, use of pneumatic tools that are sensitive to humidity. **ROTAIR** also offers an **EXTERNAL "BS" AFTER-COOLER SYSTEM**, easy to connect through an air pipe kit and is electrically powered by the compressor.

It enables standard compressors, from 2000 to 8500 lt/min (71 to 300 cfm) to work in sandblasting and other humidity-sensitive operations. Air output temperature is extremely low: ambient +2°C. Humidity in air suffers a drastic diminution. The unit is on wheels, easy to transport and to handle, built to meet the most exigent and severe working conditions.



## ROTAIR OFFERS A BROAD PANEL OF TRAILERS, TO MAKE COMPRESSORS EFFECTIVELY PORTABLE.

The undercarriage of a portable compressor is composed of:

### AXLE

The part connecting compressor to the ground, includes suspension system, wheels and all related parts. Suspensions can be assured with springs (sprung axle) or leaf springs (leaf spring axle). Wheels are of different size, to match the weight of the machine and according to the type of towing.

### LIGHTS

System of rear lights and reflectors

### BRAKING SYSTEMS

Can be with no braking system at all, simple parking brake or repulsion braking system.

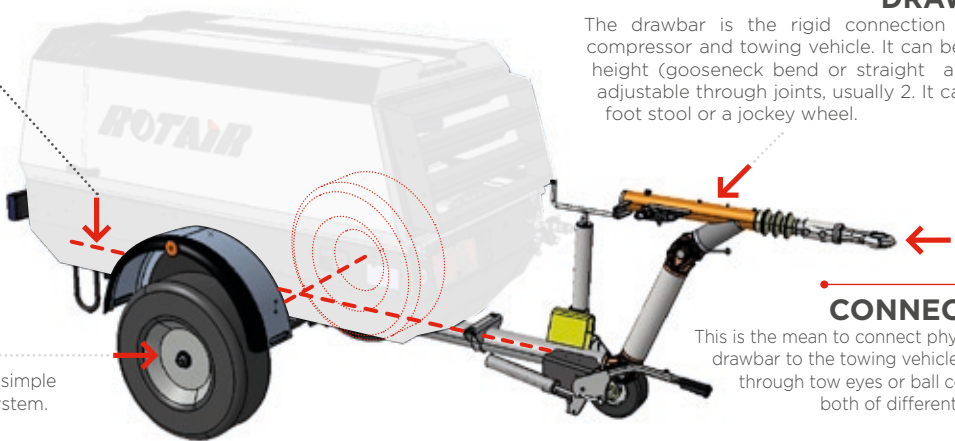

### DRAWBAR

The drawbar is the rigid connection between compressor and towing vehicle. It can be at fixed height (gooseneck bend or straight angles) or adjustable through joints, usually 2. It can have a foot stool or a jockey wheel.

### CONNECTION

This is the mean to connect physically the drawbar to the towing vehicle. It can be through tow eyes or ball connection, both of different diameter.

### STANDARD TRAILER - MDVN

So-called "gooseneck" for the peculiar shape of the drawbar. Is always without brakes. Enables slow towing (max 25 km/h) on work field but not on public roads.

### TRAILER WITH BRAKES - MDVN

Has adjustable drawbar, repulsive braking system, lights. Enables compressor to be towed on public roads, if homologated.

### STANDARD TRAILER - MDVS

Has adjustable drawbar. Is without repulsive braking system, but has a parking brake. Enables slow towing (max 25 km/h) on work field but not on public roads.

### TRAILER WITH BRAKES - MDVS

Has adjustable drawbar, repulsive braking system, lights. Enables compressor to be towed on public roads, if homologated.

### TRAILER WITH PARKING BRAKE

All types of axles and drawbars can be equipped with parking brake, a lever that blocks the wheels when the machine must be static.

### SKID ADAPTOR

Portable compressors can be delivered "ON SKID", which means without wheels but on a base with four support feet.

**ROTAIR has a special SKID ADAPTOR**, used to prepare the machine for standard skid delivery, that can be provided as separate attachment and be used to transform a towable compressor into a skid compressor. Viceversa: by removing the skid adaptor and installing an undercarriage with all its parts, the original skid machine can become towable.



**ON ROAD HOMOLOGATION** / To circulate on public roads, towed by a vehicle, a portable compressor needs to have several characteristics.

### EUROPE:

European Union has uniformed the legislation to enable towing of trailers, among those portable compressors. To be towed on public roads, a trailer shall respond to Directive 2007/46/CE. The manufacturer shall undergo a process of internal homologation by one European Ministry of transports and all machines to be towed shall be examined and approved. The exam includes the presence of all elements requested by the Directive (among others: braking system where needed, lights, reflectors, etc...). This done, the manufacturer will be issued, for each towable model, a unique reference number, that will be engraved on the chassis of the machines deemed to be towed and integrated into the specific documentation of the machine. This number, communicated by the end Customer to the Office of Circulation of the European Country where the machine will be put into operation, will enable the road homologation process without need of further presentation of documents or physical inspection and assessment by the competent Authority.

### OTHER COUNTRIES.

For other Countries outside Europe, the local legislation shall be followed. ROTAIR can provide, upon request, the specific documents and drawings that could be requested for a national road homologation. The Dealer or end Customer shall provide the specifications that the machines shall respect to be homologated. In some cases, the Dealer could modify the machines, upon authorization of ROTAIR, to conform them to the norms of the reference Country.

# FEATURED HIGHLIGHTS

## EXCLUSIVE ROTAIR INTELLIGENT SYSTEM

THE "INTELLIGENT SYSTEM" ENABLES A PRE-HEATING OF THE ENGINE WITHOUT OVERLOADING IT, THE AIREND WILL START WORKING ONLY WHEN THE PERFECT CONDITIONS ARE REACHED.

THE SAME IN TURNING OFF THE MACHINE AFTER A DEPRESSURISATION PHASE OF THE HYDRAULIC CIRCUIT, NO HAMMERING OF THE AIREND DUE TO ITS INERTIAL MOVEMENT, BUT A GRADUAL TURN-OFF.



No more need to start the machine with the air exit open (and risks of forgetting it)

All this brings:

- A correct lubrication to the screw set and the engine, even in extremely cold temperature conditions.
- A better functioning and a higher durability of all the components of the machine.
- An increase of the separator filter lifetime and no oil in the air during the next compressor's starts (and no black smoke from the exhausts pipe while turning the machine on).

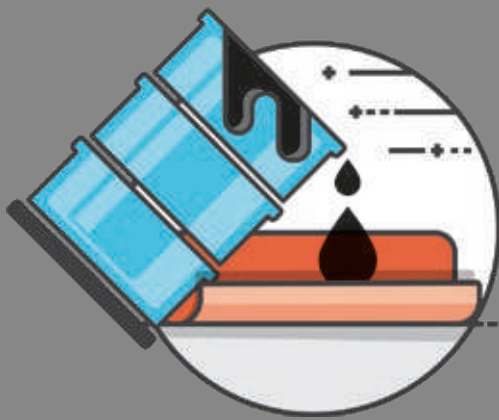

## BUNDED CHASSIS ADAPTER

This exclusive device, only for ROTAIR portable compressors, offers the possibility to have your compressor protected from accidental spills of fluids on the ground.

Removable yet solidly fixable to the compressor, it is the ultimate option where anti-spill is mandatorily required.

It is so intelligent that it enables forklift handling of the compressor.

## EASY MAINTENANCE

FULL ACCESSIBILITY FOR EASY AND RAPID MAINTENANCE AND SERVICE

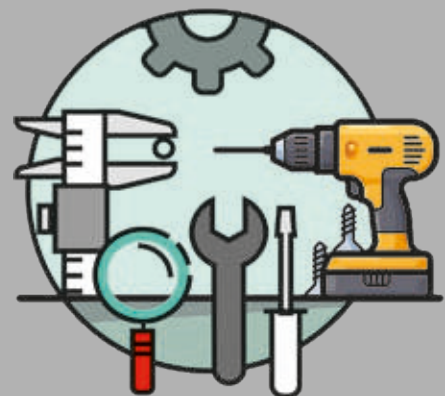



PORTABLE



# COMPRESSORS

**WARRANTY,  
DURATION and  
RELIABILITY**

are assured with  
THE EXCLUSIVE USE  
of original spare parts.





PORTABLE



## COMPRESSORS

**SCREW  
SUPERSILENT**  
for civil  
engineering  
&  
MUCH MORE



# ROTAIR®

VIA BERNEZZO, 67  
12023 ▶ CARAGLIO (CN) ▶ ITALY



Tel: +39 0171.619676  
Fax: +39 0171.619677



[www.rotairspa.com](http://www.rotairspa.com)  
[info@rotairspa.com](mailto:info@rotairspa.com)

Company certified  
ISO 9001:2015

ISO 9001

BUREAU VERITAS  
Certification



ROTAIR - A brand of ELGI Equipments Ltd.